



# MEDIN

## FRANCE

**MATERIEL**

**STOMATOLOGIE**

**IMPLANTOLOGIE**

**MAXILLO-FACIALE**

**ORL**

**OPHTALMOLOGIE**

**ESTHETIQUE-PLASTIE**



ORL



Compact et efficace, **PIEZOTOME® Solo M+** réunit tous les composants les plus puissants, fiables et sûrs de la gamme M+ pour une performance et efficacité maximales



## Indications Cliniques

**Actif sur les tissus durs tout en préservant les tissus mous.**

Ostéotomies, ostéoplasties, rhinoplastie, lissage des petits os où la sécurité et la précision sont essentielles.

**Kit Expert Rhinoplastie Dr Gerbault**  
Stérilisable Ref: F87689

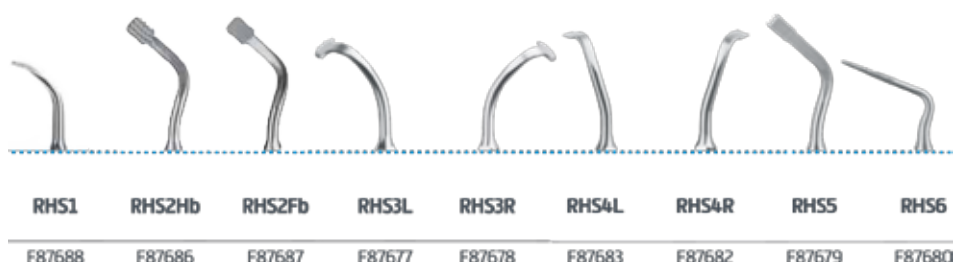

● **Kit Essentiel Rhinoplastie Dr Gerbault**  
Stérilisable Ref: F87681



**ImplantCenter™ M+** est un concept unique associant la puissance d'un moteur rotatif et la sécurité de l'instrumentation piézoélectrique. Il assure ainsi une indépendance totale du chirurgien et ouvre la voie à une multitude de chirurgies.



## Indications Cliniques

**Actif sur les tissus durs tout en préservant les tissus mous.**

Ostéotomies, ostéoplasties, rhinoplastie, forage, lissage des petits os où la sécurité et la précision sont essentielles.

Les dispositifs ACTEON (COMEG) sont certifiés bloc opératoire. Approuvé par un organisme indépendant. Chaque dispositif remplit les normes réglementaires médicales les plus exigeantes.

# Pompe d'infiltration DISPENSER DP30

**NOUVAG<sup>+</sup>**

Le distributeur DP30 est une pompe d'infiltration universelle qui convient parfaitement dans les applications tumescentes et aux traitements à la veine.  
Le volume d'infiltration est contrôlé à l'aide du potentiomètre rotatif et de la pédale de pied.

**Ergonomique**

Le plus léger et le plus petit de sa catégorie  
Surface simple à nettoyer

**Voyant ON / OFF**

Indique que l'appareil est sous tension

**Potence**

Permet de suspendre les bouteilles de solution d'infiltration standard

**Mise en place facile**  
des lignes d'irrigation

**Pompe à faible bruit**

**Réglage de la pompe précis**

**Accès frontal à la pompe**



**DP30**



**DP30  
LIPO  
PLUS**

**Caractéristiques techniques**

- Tension : 230 Volt 50 Hz
- Puissance de sortie : 40 VA
- Débit : 1-210 ml/min
- Dimensions : 260 X 250 X 110 mm
- Poids : 2.5 kg
- Référence 4187

**Caractéristiques techniques**

- Tension : 230 Volt 50 Hz
- Puissance de sortie : 40 VA
- Débit : 1-400 ml/min
- Dimensions : 260 X 250 X 110 mm
- Poids : 3.4 kg
- Référence 4163



Kit d'irrigation pour DP30 et DP30+  
Luer Lock  
Stérile  
Boîte de 10  
Ref : 6022

**Bien Air**



### **OSSEODOC - ref 1700168**

Peu encombrante, robuste et stable, l'OSSEODOC pour la microchirurgie osseuse est pratique et efficace. Son moteur à accouplement ISO 3964, le standard le plus utilisé au monde, offre la possibilité d'utiliser des pièces à main, microscies et autres instruments de chirurgie. Ses touches permettent de sélectionner 4 plages de vitesses du moteur, le sens de rotation, deux options d'irrigation et 4 débits de la pompe péristaltique. La plupart de ces fonctions sont disponibles sur la pédale. Des témoins lumineux et sonores indiquent les fonctions activées.

Livré avec:

- Console de commande et de programmation
- Micromoteur BASCH + cordon
- Pompe péristaltique
- Pédale de commande Multifonctions
- Potence

Micromoteur BASCH seul	Réf :	1600076
Cordon BASCH seul	Réf :	1600342
Micromoteur BASCH + Cordon	Réf :	1700074
Pédale OSSEODOC	Réf :	1600407
Ligne d'irrigation	Réf :	MED 0300

Cassette sté micromoteur      Réf :      CSS

### **HighSurg 30**

Est la solution complète pour la motorisation des chirurgies en stomatologie, maxillo-faciale et l'ORL.

C'est une unité de commande intuitive avec une technologie avancée pour connecter les micro-scies ORL et les pièces à main chirurgicales.

Ce système précis offre performance et efficacité. Il réduit remarquablement le gonflement des tissus et des ecchymoses et favorise la guérison du patient.

#### **LES PLUS PRODUITS**

- 2 MOTEURS SIMULTANES
- POMPE D'IRRIGATION INTEGREE

**NOUVAG+**





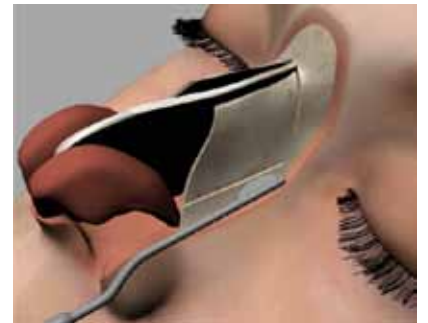

# MICRO-SCIE

**LAME MICRO-SCIE**

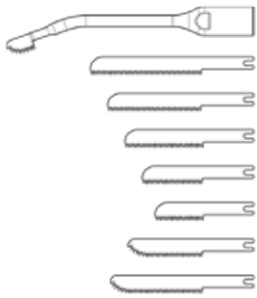

Utilisation	Longueur de travail	Ref stérile	Ref non stérile
Rhinology	6.0 mm	5112snou	5112rnou
Straight	26.0 mm	5045snou	5045rnou
Straight	22.0 mm	5044snou	5044rnou
Straight	18.0 mm	5043snou	5043rnou
Straight	14.0 mm	5042snou	5042rnou
Straight	11.0 mm	5041snou	5041rnou
Rounded	17.0 mm	5105snou	5105rnou
Rounded	21.0 mm	5106snou	5106rnou



Ref:5040NOU



Ref:5110NOU



Ref:5090NOU

**LAME MICRO-SCIE OSCILLANTE**

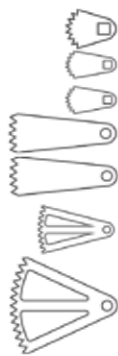

Profondeur de coupe	Longueur de travail	Cops 33mm	Cops 45mm	Ref stérile	Ref non stérile
3.0 mm	6.0 mm	+		5101snou	5101rnou
6.3 mm	6.0 mm	+		5100snou	5100rnou
6.3 mm	6.0 mm	+		5099snou	5099rnou
13.3 mm	6.0 mm	+		5093snou	5093rnou
13.3 mm	6.0 mm	+		5096snou	5096rnou
13.3 mm	10.0 mm	+		5094snou	5094rnou
13.3 mm	10.0 mm	+		5097snou	5097rnou
13.3 mm	15.0 mm	+		5095snou	5095rnou
13.3 mm	15.0 mm	+		5098snou	5098rnou

**SGR2-E (mouvement de va-et-vient 1,8 mm)**

**NON LUMIÈRE** MODÈLE : SGR2-E RÉFÉRENCE : SH162

- Réduction 3:1 ● Couple : 12 600 balayages/min ● Bague de spray externe



**SGO2-E (mouvement oscillant 17°)**

**NON LUMIÈRE** MODÈLE : SGO2-E RÉFÉRENCE : SH164

- Réduction 3:1 ● Couple : 12 600 balayages/min ● Bague de spray externe



**SGT2-E (mouvement sagittal 3°)**

**NON LUMIÈRE** MODÈLE : SGT2-E RÉFÉRENCE : SH163

- Réduction 3:1 ● Couple : 12 600 balayages/min ● Bague de spray externe



**Lames pour Mouvement de va-et-vient**

MODÈLE : SGR-1  
RÉFÉRENCE : Y900072

- Épaisseur de lame de 0,35 mm ● Lot de 10 lames



MODÈLE : SGR-2  
RÉFÉRENCE : Y900073

- Épaisseur de lame de 0,35 mm ● Lot de 10 lames



MODÈLE : SGR-3  
RÉFÉRENCE : Y900074

- Épaisseur de lame de 0,35 mm ● Lot de 10 lames



**Lames pour Mouvement sagittal**

MODÈLE : SGT-1  
RÉFÉRENCE : Y900075

- Épaisseur de lame de 0,35 mm ● Lot de 10 lames



MODÈLE : SGT-2  
RÉFÉRENCE : Y900076

- Épaisseur de lame de 0,35 mm ● Lot de 10 lames



**Lames pour Mouvement oscillant**

MODÈLE : SGO-1  
RÉFÉRENCE : H174034

- Épaisseur de lame de 0,3 mm ● Lame unique



MODÈLE : SGO-2  
RÉFÉRENCE : H174044

- Épaisseur de lame de 0,3 mm ● Lame unique



MODÈLE : SGO-3  
RÉFÉRENCE : H174031

- Épaisseur de lame de 0,3 mm ● Lame unique



MODÈLE : SGO-4  
RÉFÉRENCE : H174041

- Épaisseur de lame de 0,3 mm ● Lame unique



MODÈLE : SGO-5  
RÉFÉRENCE : H174032

- Épaisseur de lame de 0,35 mm ● Lame unique



MODÈLE : SGO-6  
RÉFÉRENCE : H174042

- Épaisseur de lame de 0,35 mm ● Lame unique





- Système multifonctionnel
- Caméra et source de lumière
- Résolution Full HD
- Menu multilingue
- Enregistrement d'images/vidéos

**TWIN-CAM HD**

Caméra Full HD, avec source de lumière LED intégrée et USB  
507085FX



- Résolution Full HD
- Obturateur haute vitesse
- Menu multilingue
- 3 paramètres utilisateur stockables
- Tête de caméra déportée
- Enregistrement d'images/vidéos

**ONE-CAM HD**

Caméra Full HD  
507105FX

**accessoires**



**Cassette stérilisation 2 endoscopes**

290 x 80 x 52 mm 708590FX  
460 x 80 x 52 mm 708593FX

**Cassette stérilisation 1 endoscope**

290 x 80 x 52 mm 708591FX  
460 x 80 x 52 mm 708592FX



**Source lumineuse LED à batterie**

Avec chargeur USB magnétique Caméra Full HD  
507105FX



**Adaptateur zoom TV**

f=16-35 mm, monture C, étanche 507034FX



**Adaptateur TV**

f=18 mm, monture C, étanche 507018FX  
f=22 mm, monture C, étanche 507022FX  
f=24 mm, monture C, étanche 507024FX  
f=25 mm, monture C, étanche 507025FX  
f=28 mm, monture C, étanche 507028FX



**Câble de lumière à fibre optique**

Avec adaptateurs Storz/Storz, autoclavable / 1,8 m, Ø 3.5 mm  
Avec adaptateurs Storz/Storz, autoclavable / 1,8 m, Ø 4.9 mm  
Avec adaptateurs Storz/Storz, autoclavable / 2.3m, Ø 4.9 mm



**Sialoscope**

0°, Long 120 mm, Ø 0.9 mm 710819FX  
Canal opérateur Ø 0,45 mm / 0°, Long 110 mm, Ø 1,1 mm 710820FX  
Canal opérateur Ø 0,62 mm / 0°, Long 120 mm, Ø 1,4 mm 710830FX  
Canal opérateur Ø 0,62 mm / 0°, Long 100 mm, Ø 1,2 mm 710840FX



Optique de sinuscopie HD Autoclavable

750300FX	4 mm	185 mm	0°
750330FX	4 mm	185 mm	30°
750345FX	4 mm	185 mm	45°
750370FX	4 mm	185 mm	70°

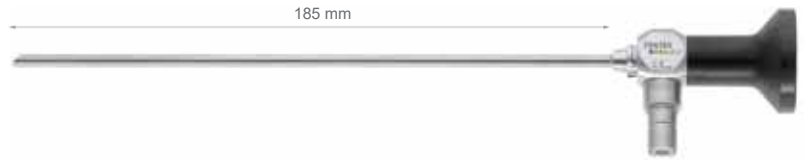
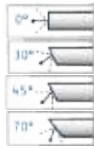

Optique de sinuscopie HD Autoclavable

730100FX	3 mm	185 mm	0°
730330FX	3 mm	185 mm	30°
730345FX	3 mm	185 mm	45°
730370FX	3 mm	185 mm	70°



Optique d'Otologie / sinuscopie HD Autoclavable

728200FX	2.7 mm	140 mm	0°
730330FX	2.7 mm	140 mm	30°
730370FX	2.7 mm	140 mm	70°



Optique d'Otologie / sinuscopie HD Autoclavable

728500FX	2.7 mm	110 mm	0°
730530FX	2.7 mm	110 mm	30°
730570FX	2.7 mm	110 mm	70°



Optique d'Otologie / sinuscopie HD Autoclavable

716100FX	4.0 mm	50 mm	0°
716330FX	4.0 mm	50 mm	30°
717100FX	2.7 mm	75 mm	0°
717130FX	2.7 mm	75 mm	30°
717170FX	2.7 mm	75 mm	70°
717100FX	1.9 mm	60 mm	0°
717130FX	1.9 mm	60 mm	30°



Laryngoscope HI-View Autoclavable

750270FX	4 mm	185 mm	70°
----------	------	--------	-----



Laryngo-pharyngoscope Hi-View Autoclavable

520970FX	8 mm	190 mm	70°
522090FX	10 mm	200 mm	90°



Laryngo-pharyngoscope Hi-View Autoclavable

521670FX	6 mm	160 mm	70°
521170FX	10 mm	160 mm	70°
521190FX	10 mm	160 mm	90°
Fort grossissement			
521671FX	6 mm	160 mm	70°



**Nasopharyngoscope**  
0°, Long 300 mm, Ø 3.4 mm 700710FX



**Nasopharyngoscope enfant**  
0°, Long 320 mm, Ø 3.8 mm 700761FX  
Avec canal opérateur  
0°, Long 320 mm, Ø 4.0 mm 700762FX

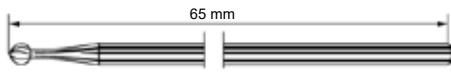

105- Pièce-à-main long

∅ 2.35 mm

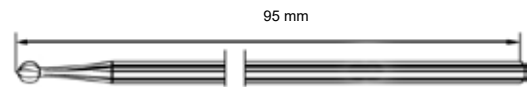

107- Pièce-à-main extra-long

∅ 2.35 mm

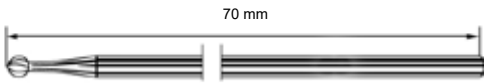

106- Pièce-à-main extra-long

∅ 2.35 mm

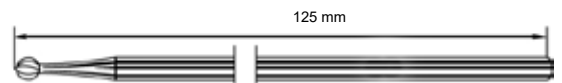

108- Pièce-à-main extra-long

∅ 2.35 mm

### Fraises diamantées

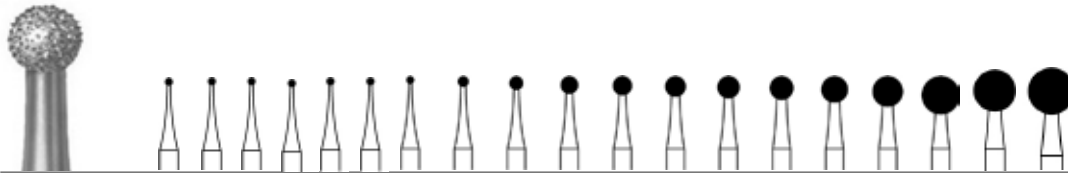

#### 242

70mm	106	006	007	008	010	012	014	016	018	021	023	025	027	031	035	040	045	050	060	070
95mm	107	006			010		014		018		023		027	031	035	040	045	050	060	070
125mm	108	006		008	010		014		018	021	023		027	031	035	040	045	050	060	070

### Fraises carbure tungstène

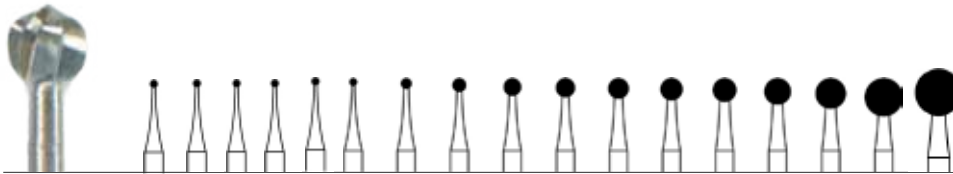

#### HM236

70mm	106	005	008	010	012	014	016	018	021	023	027	031	035	040	045	050	060	070
95mm	107	005	008	010				018		023		031	035	040	045	050	060	070
125mm	106									023		031		040		050	060	070

### Fraises acier inox



#### RF236

70mm	106	006	007	008	010	014	018	023	027	031	035	040	045	050	060	070
95mm	106	006		008	010	014	018	023	027	031	035	040	045	050	060	070
125mm	106	006		008	010	014	018	023	027	031	035	040	045	050	060	070

Fraises à Os LINDEMANN

Pour tout autre modèle  
de fraise.  
Consultez nous.

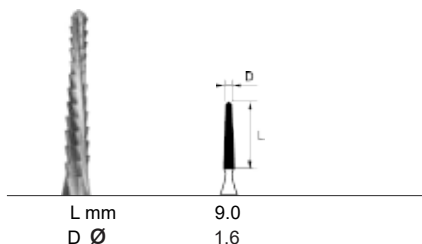

L mm 9.0  
D Ø 1.6

HM162

70mm 106 016

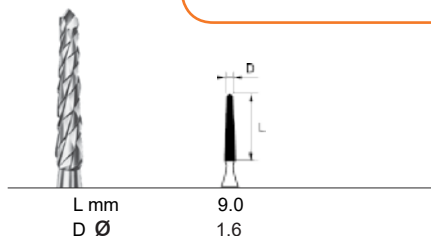

L mm 9.0  
D Ø 1.6

HM162A

70mm 106 016

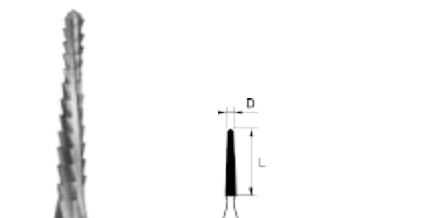

L mm 10.0  
D Ø 2.1

HM166

65mm 105 021

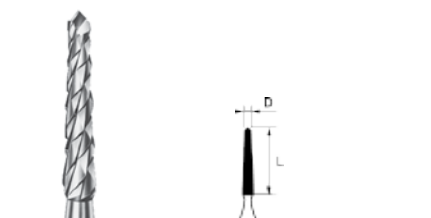

L mm 10.0  
D Ø 2.1

HM166A

70mm 106 021

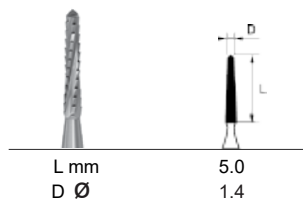

L mm 5.0  
D Ø 1.4

RF163

70mm 106 014

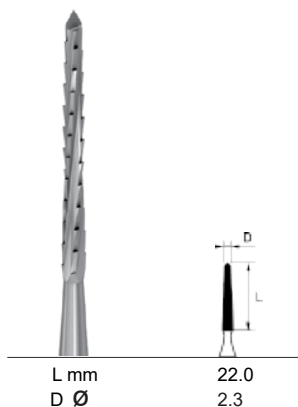

L mm 22.0  
D Ø 2.3

RF168

44.5mm 104 023  
70mm 106 023

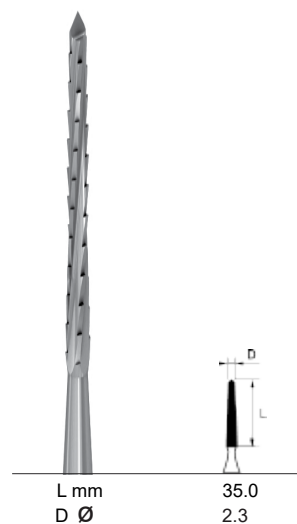

L mm 35.0  
D Ø 2.3

RF169

44.5mm 104 023  
70mm 106 023



**Abaisse-langue inox**  
Adulte 00 100  
Enfant 00 101

**Abaisse-langue inox fenêtré**  
00 102



**Canule d'aspiration et irrigation Cône Luer**

Droite		Coudée	
385 005	ø 0.5 mm	386 005	
385 006	ø 0.6 mm	386 006	
385 007	ø 0.7 mm	386 007	
385 008	ø 0.8 mm	386 008	
385 009	ø 0.9 mm	386 009	
385 010	ø 1.0 mm	386 010	
385 012	ø 1.2 mm	386 012	
385 015	ø 1.5 mm	386 015	
385 018	ø 1.8 mm	386 018	
385 020	ø 2.0 mm	386 020	
385 025	ø 2.5 mm	386 025	
385 030	ø 3.0 mm	386 030	



**Raccord tournant embout Luer**  
197 00 0060



**Anneau de St Paul**  
198 00 0010



**Anneau de Trautmann**  
Mousse 198 00 0020  
Tranchant 198 00 0030



**Manche coudé Politzer**  
198 00 0050



**Aiguilles paracentèse Politzer**  
Adulte 198 00 0051  
Enfant 198 00 0052  
Nourrisson 198 00 0053



**Crochet mousse à corps étrangers Politzer**  
Petite Taille 198 00 0056  
Moyenne Taille 198 00 0057  
Grande Taille 198 00 0058



**Anse de Billeau**  
198 00 0070



**Anse de Snellen**  
198 38 2610



**Crochet de Moulonguet -16cm**  
198 00 0090



**Marteau à réflexes de Babinsky**  
198 10 0100



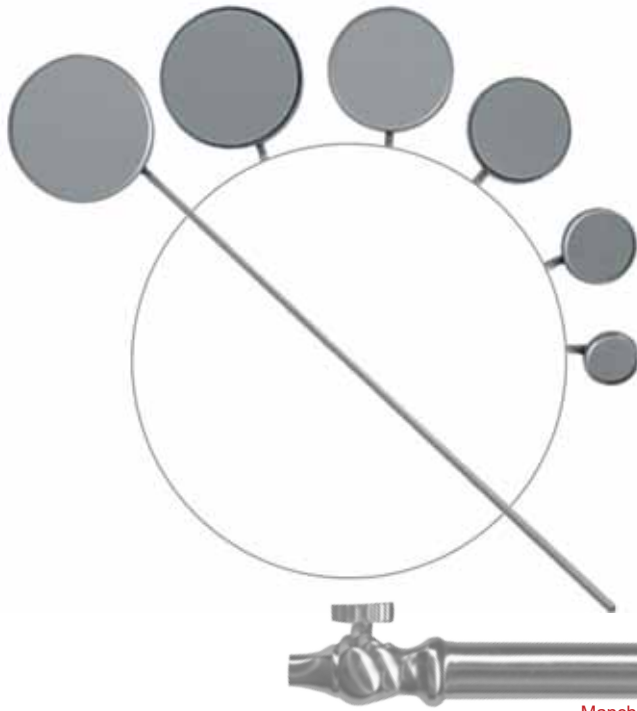

Miroirs Laryngiens

Tailles	Ø	Ref
00	08 mm	198 10 0008
0	10 mm	198 10 0010
1	12 mm	198 10 0012
2	14 mm	198 10 0014
3	16 mm	198 10 0016
4	18 mm	198 10 0018
5	20 mm	198 10 0020
6	22 mm	198 10 0022
7	24 mm	198 10 0024
8	26 mm	198 10 0026
9	28 mm	198 10 0028
10	30 mm	198 10 0030

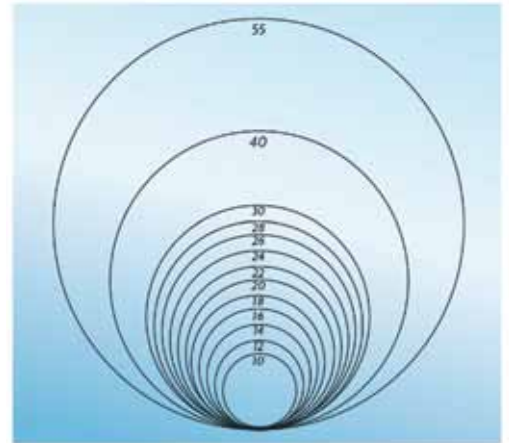

Manche à vis pour miroirs laryngiens  
198 10 0000



Pince de Lucae - 14 cm

Mors striés	198 00 0100
Mors à griffes 1x2	198 00 0110
Mors en cuiller	198 00 0120



Pince de Politzer - 14 cm

Otologie

Mors striés	198 00 0130
Mors striés très fins	198 00 0140
Mors à griffes 1x2	198 00 0150
Mors en cuiller	198 00 0160

Nasale

Mors striés	198 00 0170
Mors à griffes 1x2 très fine	198 00 0180



Sondes Cannelées

13.0 cm	120 11013
14,5 cm	120 11014
16.0 cm	120 11016



Porte coton auriculaire - boîte de 10

ø 1.0 mm	198 00 701
ø 1.2 mm	198 00 702

Pince Adson sans griffes

12 cm	196 17 0012
15 cm	196 17 0015



Pince Adson avec griffes

12 cm	196 17 0112
15 cm	196 17 0115



Pince Adson mors tungstène

12 cm sans griffes	196 17 0412
12 cm avec griffes	196 17 1412





Speculum de BOUCHERON

5 mm	144 01850
6 mm	144 01860
7 mm	144 01870
8 mm	144 01880



Speculum de Le MEE

Tailles	Ø	Ref
N°1	1 mm	01000
N°2	2 mm	01020
N°3	3 mm	01030
N°4	4 mm	01040
N°5	5 mm	01050
N°6	6 mm	01060
N°7	7,5 mm	01080



Speculum de CAUSSE

5 mm	01051
6 mm	01061
7 mm	01071
8 mm	01081



Speculum nasal de VACHER

Adulte	05015
Enfant	05016
Nourrisson	05017



Speculum nasal de DUPLAY

Adulte	05110
Enfant	05111
Nourrisson	05112



Speculum nasal de PALMER

N°1	13 mm	0513
N°2	12 mm	0512
N°3	10 mm	0510
N°4	8 mm	0508
N°5	5 mm	0505



Speculum de KILLIAN

35 mm	146 12035
50 mm	146 12050
75 mm	146 12075
90 mm	146 12090



Speculum de HARTMANN HALLE  
15 cm

Taille 1	146 10201
Taille 2	146 10202
Taille 3	146 10203



Trocard D'ALBERTINI

198 00 0200

MEDIN  
FRANCE



**Speculum Nasal enfant de TIECK-HALL**  
 13 cm  
 Taille bébé 17,5 mm 040100FX  
 Taille adolescent 21,0 mm 040110FX



**Speculum Nasal de HARTMANN-HALL**  
 15,5 cm  
 Taille enfant 29 mm 041101FX  
 Taille adolescent 33 mm 041102FX  
 Taille adulte 37 mm 041103FX



**Speculum Nasal BECKMANN**  
 13 cm  
 Taille enfant 27 mm 043101FX  
 Taille adulte 34 mm 043102FX



**Speculum Nasal de BECKMANN**  
 13 cm  
 Taille bébé 17,5 mm 041800FX  
 Taille adolescent 22 mm 041801FX  
 Taille adulte 29 mm 041803FX



**Speculum Nasal de KILLIAN**  
 14 cm  
 40 mm 042101FX  
 55 mm 042102FX  
 75 mm 042103FX  
 90 mm 042104FX

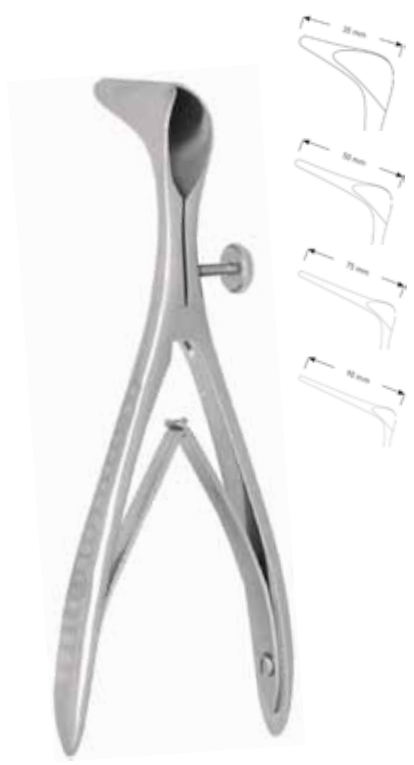

**Speculum Nasal de COTTLE**  
 13,5 cm  
 35 mm 300101FX  
 55 mm 300102FX  
 75 mm 300103FX  
 90 mm 300104FX





Speculum Nasal de COTTLE  
13,5 cm

35 mm	300601FX
55 mm	300602FX
75 mm	300603FX
90 mm	300604FX

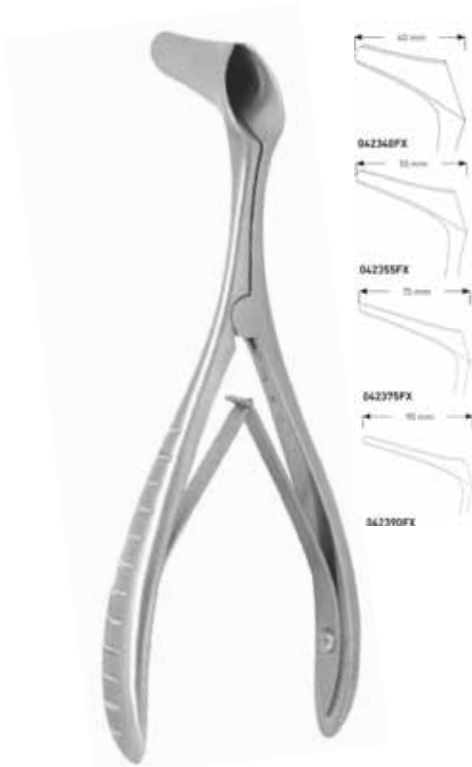

Speculum Nasal de KILLIAN-STRUUCKEN  
14 cm

40 mm	042340FX
55 mm	042355FX
75 mm	042375FX
90 mm	042390FX

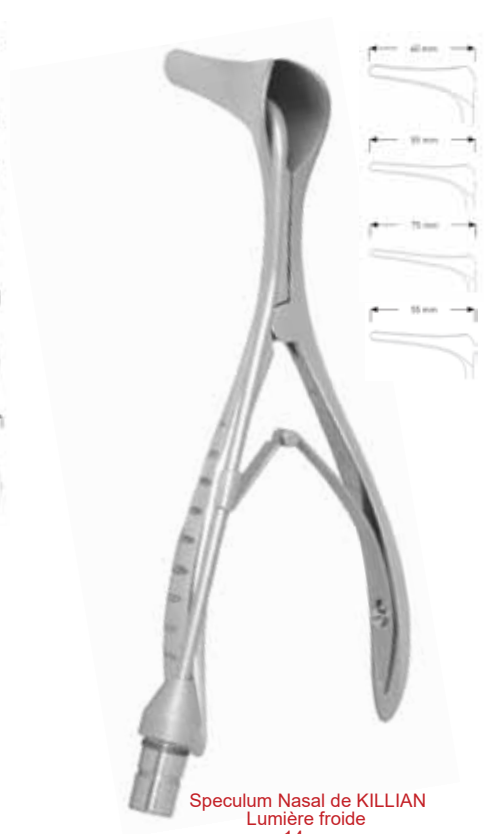

Speculum Nasal de KILLIAN  
Lumière froide  
14 cm

40 mm	042740FX
55 mm	042755FX
75 mm	042775FX
90 mm	042790FX



Speculum Nasal de KILLIAN  
Lame droite courte dentée  
14 cm

55 mm	397701FX
-------	----------



Speculum Nasal de KILLIAN  
Lame gauche courte dentée  
14 cm

55 mm	397702FX
-------	----------



Speculum Nasal de KILLIAN  
Lames longue + courte dentée  
14 cm

Droit	75 mm	397705FX
Gauche	75 mm	397706FX



**Pince Halstead - Mosquito - 12 cm**

- Droite sans griffes 112 22012
- Droite avec griffes 112 23012
- Courbe sans griffes 112 22112
- Courbe avec griffes 112 23112

**Pince Halstead - Mosquito - 14 cm**

- Droite sans griffes 112 22014
- Droite avec griffes 112 23014
- Courbe sans griffes 112 22114
- Courbe avec griffes 112 23114



**Pince de KELLY - 14 cm**

- Droite 112 24014
- Courbe 112 24114



**Pince Leriche fine - 15 cm**

- Droite sans griffes 112 38015
- Droite avec griffes 112 38215
- Courbe sans griffes 112 38115
- Courbe avec griffes 112 38315



**Pince de KOCHER**

- 14 cm Droite 112 32214
- 16 cm Droite 112 32216
- 14 cm Courbe 112 32314
- 16 cm Courbe 112 32316



**Pince de PEAN**

- 14 cm Droite 112 36814
- 16 cm Droite 112 36816



**Pince à champ - BACKHAUS**

- 9 cm 114 11109
- 11 cm 114 11111
- 13 cm 114 11113
- 15 cm 114 11115



Pince en coeur de COLLIN - 16 cm  
112 37616



Pince de Chaput - 13 cm  
112 37013



Pince d'ALLIS avec griffes 5x6  
15 cm 164 12015  
19 cm 164 12019  
22 cm 164 12022  
24 cm 164 12024



Pince de BENGOLEA  
20 cm Droite 112 38420  
26 cm Droite 112 38426  
20 cm Courbe 112 38520  
26 cm Courbe 112 38526



Pince à tamponnement  
Hartmann

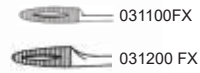

031100FX  
031200 FX

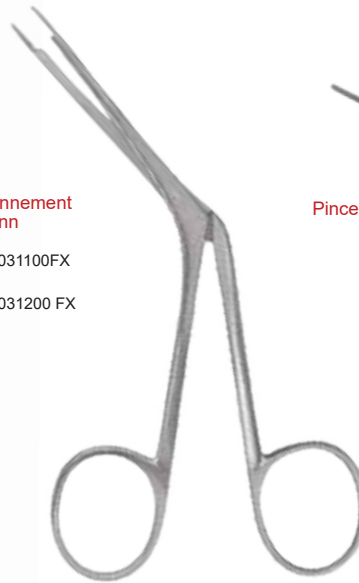

Pince de Lubet Barbon  
146 16520



Pince à tamponnement  
TILLEY 14cm  
028500FX





**Aiguille de ponction de LICHTWITZ**  
 Ø 1.5 mm long 100 mm 049415FX  
 Ø 1.8 mm long 100 mm 049418FX  
 Ø 2 mm long 100 mm 049420FX



**Aiguille d'injection Coudé**  
 Ø 0.8 mm long 105 mm 201200FX  
**Droite**  
 Ø 0.8 mm long 105 mm 201210FX



**Décolleur aspiration de GORNEY**  
 Ø 3 mm long 190 mm 305900FX



**Canule aspiration chir inox**  
**Frazier Ø 2.0 mm droite**  
 196 01 0202  
**Frazier Ø 3.0 mm droite**  
 196 01 0200  
**Frazier Ø 4.0 mm droite**  
 196 01 0201



**Canule d'aspiration de MASPETIOL**  
 Mandrin à trou  
 Ø 2.0 mm 196 99 0120  
 Ø 3.0 mm 196 99 0130  
 Ø 4.0 mm 196 99 0140



**Canule d'aspiration de HOUSE STEKERS avec irrigation intégrée**  
 Ø 2.5 mm 196 99 0125  
 Ø 3.5 mm 196 99 0135



**Canule d'aspiration de MARTIN - 10 cm**  
 Ø 2.0 mm 196 99 0302



**Décolleur aspiration de GUILLEN**  
 Ø 4 mm long 200 mm 198 10 0720





**Canule irrigation Van Eicken  
Malléable - 15cm**

Ø 2.5 mm long 150 mm 049802FX  
Ø 3.0 mm long 150 mm 049803FX  
Ø 4.0 mm long 150 mm 049804FX



**Canule irrigation Van Eicken  
15cm**

Ø 2.5 mm long 150 mm 049702FX  
Ø 3.0 mm long 150 mm 049703FX  
Ø 4.0 mm long 150 mm 049704FX



**Canule irrigation Van Eicken  
15cm**

Ø 2.5 mm long 150 mm 049712FX  
Ø 3.0 mm long 150 mm 049713FX  
Ø 4.0 mm long 150 mm 049714FX



**Canule Frazier  
avec contrôle aspiration**

Ø 2.0 mm long 100 mm 110106FX  
Ø 2.3 mm long 100 mm 110107FX  
Ø 2.6 mm long 100 mm 110108FX  
Ø 3.3 mm long 100 mm 110110FX  
Ø 4.0 mm long 100 mm 110112FX  
Ø 5.0 mm long 100 mm 110115FX



**Canule Frazier  
avec contrôle aspiration**

Ø 2.0 mm long 100 mm 110116FX  
Ø 2.6 mm long 100 mm 110118FX  
Ø 3.3 mm long 100 mm 110120FX  
Ø 4.0 mm long 100 mm 110122FX  
Ø 5.0 mm long 100 mm 110125FX



**Canule Frazier sinus frontal  
avec contrôle aspiration  
malléable**

Ø 3.3 mm long 150 mm (courbée) 111710FX  
Ø 3.3 mm long 150 mm (très courbée) 111810FX



**Canule Frazier  
graduation de 50 à 90 mm**

Ø 2 mm long 100 mm 11106FX  
Ø 2.3 mm long 100 mm 11107FX  
Ø 2.6 mm long 100 mm 11108FX  
Ø 3 mm long 100 mm 11109FX  
Ø 3.3 mm long 100 mm 11110FX  
Ø 4 mm long 100 mm 11112FX  
Ø 5 mm long 100 mm 11115FX



**Canule aspiration chir inox  
Frazier Ø 2.0 mm coudée**

196 01 0205

**Frazier Ø 3.0 mm coudée**

196 01 0203

**Frazier Ø 4.0 mm coudée**

196 01 0204



**Canule aspiration inox 19 cm Ø 3.0 mm**

196 33 3320

**Canule aspiration inox 19 cm Ø 4.0 mm**

196 33 3420

**Canule aspiration inox 19 cm Ø 6.0 mm**

196 33 3620



Adaptateur rotatif  
pour tuyau d'aspiration  
270026FX



Manche avec contrôle  
d'aspiration  
270025FX



Cassette pour Set EES, avec couvercle et  
supports en silicone, 270 x 170 x 35 mm  
270000FX

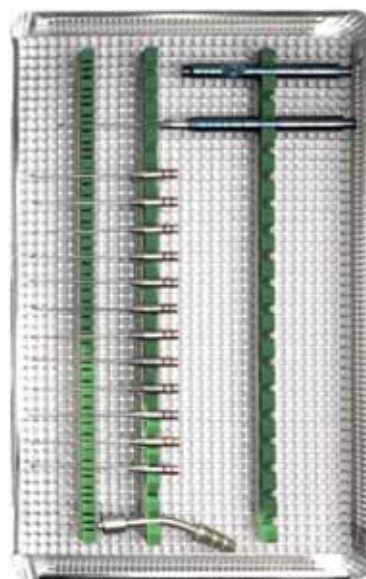

Dissecteur avec aspiration  
Court gauche 270045FX  
Court droit 270065FX



Moyen, gauche  
270046FX



Moyen, droite  
270066FX



Long, gauche  
270047FX



Long, droite  
270067FX



Courbé en S  
270080FX



Couteau ovale  
d'aspiration  
270120FX



Crochet  
angulé  
270225FX



Couteau  
rond  
270235FX

Dissecteurs Otologie  
avec aspiration intégrée



**Sonde double pour sinus frontal**  
Ø1.2 mm long 190mm  
418719FX

**Sonde double pour sinus frontal**  
Ø1.2 mm long 21mm  
418825FX

**Sonde double pour sinus frontal**  
Ø1.2 mm long 21mm  
418826FX

**Décolleur 16 cm sinus frontal**  
Ø2.5 mm 407125FX  
Ø3.0 mm 407130FX  
Ø4.0 mm 407140FX  
Ø5.0 mm 407150FX

**Décolleur de LEMPert**  
2 mm Courbe 144 80316  
3 mm Courbe 144 80516

**Décolleur - FISCH**  
5 mm long 17 cm  
161900FX

**Couteau faucille**  
Pointu, droit 418401FX  
Rond 418402FX  
Pointu, courbé gauche 418403FX  
Pointu, courbé droite 418404FX

**Curette pour sinus frontal**  
2.7 x 6 mm coudé à 50°  
418204FX  
2.7 x 6 mm coudé à 90°  
418205FX



**Curette de WILLIGER**  
14 cm

00/0 2,5 / 3,0 mm 132 49600  
0/1 3,0 / 3,5 mm 132 49601  
1/2 3,5 / 4,0 mm 132 49602

**Curette de HOUSE**

1,0 / 1,2 mm Rond 172600FX  
1,0 / 1,2 mm Oval 172700FX  
1,5 / 1,8 mm Oval 172701FX  
2,2 / 2,5 mm Oval 172702FX  
2,3 / 2,7 mm Oval 172703FX



**Curette de Fromaget**  
14 cm

3 mm forme allongée  
198 00 0260



**Curette de LEMPert**  
21 cm

00000 2.5 x 2.9 143150FX  
0000 2,3 x 3.5 143140FX  
000 2.9 x 4.3 143130FX  
0 3.5 x 5.3 143120FX  
00 3.9 x 6.3 143110FX  
0 4.5 x 6.6 143101FX  
1 4.8 x 7.8 143102FX



**Curette de LEMPert**  
17 cm

000 2.5 x 4.0 142130FX  
00 3.0 x 5.0 142120FX  
0 3.5 x 5.5 142100FX  
1 4.5 x 7.0 142101FX  
2 5.2 x 8.0 142102FX  
3 6.0 x 9.0 142103FX



**Curette de LIMA**

Rigide 198 20 0803  
Malléable 198 20 0813  
5mm 198 20 0805 198 20 0815



**Couteau rond de ROSEN**  
 16.5 cm - droit

Taille 1	150111FX
Taille 2	150112FX
Taille 3	150113FX
Taille 4	150114FX
Taille 5	150115FX
Taille 6	150116FX
Taille 7	150117FX



**Couteau rond de ROSEN**  
 16.5 cm - 30°

Taille 1	150131FX
Taille 2	150132FX
Taille 3	150133FX
Taille 5	150135FX
Taille 7	150137FX



**Couteau rond de ROSEN**  
 16.5 cm - 45°

Taille 1	150101FX
Taille 2	150102FX
Taille 3	150103FX
Taille 4	150104FX
Taille 5	150105FX
Taille 6	150106FX
Taille 7	150107FX



**Couteau rond de ROSEN**  
 16.5 cm - 90°

Taille 1	150161FX
Taille 2	150162FX
Taille 3	150163FX
Taille 5	150165FX
Taille 7	150167FX



**Aiguille de Wullstein**  
 16.5 cm

154100FX	154200FX
154300FX	154400FX
154500FX	154600FX
154700FX	154800FX

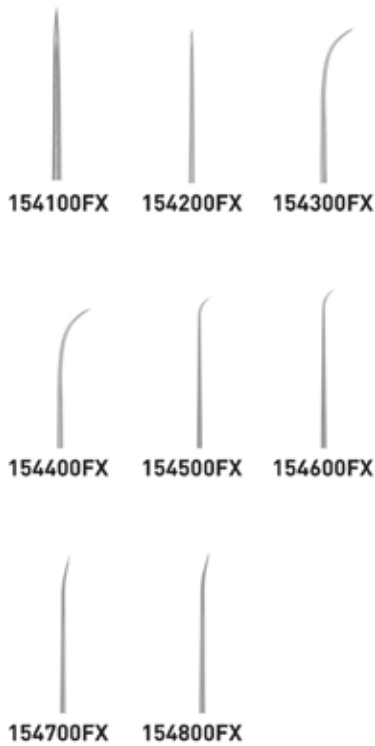

**Aiguille de Wullstein**  
 avec bague couleur  
 16.5 cm

154100FX8	154200FX8
154300FX8	154400FX8
154500FX8	154600FX8
154700FX8	154800FX8





Micro-rape  
16.5 cm  
150600FX



Couteau lancette  
de Rosen - 45°  
16.5 cm  
2 X 3 mm 151100FX



Couteau à rabat  
de Ronis  
15 cm  
7 mm 151300FX



Couteau  
de Plester  
16.5 cm  
3.5 x 2.3 mm 151600FX



Couteau à rouleau  
de Schuhknecht  
16.5 cm  
3.2 mm 152200FX



Couteau à rouleau  
de Schuhknecht  
16.5 cm  
3.2 mm 152100FX



Couteau de Wullstein  
16.5 cm  
153600FX



Couteau faucille  
de Plester - Courbé  
16.5 cm  
153700FX



Couteau faucille  
de Plester - Très courbé  
16.5 cm  
153730FX



Couteau faucille  
de Plester  
Courbé très fin  
16.5 cm  
153800FX



Couteau faucille  
de Dornhoffer  
Courbé très fin  
16.5 cm  
153900FX



**Crochet de GERLACH**  
16.5 cm  
1.25 mm 156300FX

**Crochet de Plester**  
15.5 cm  
2 mm 156700FX

**Crochet de Plester**  
16.5 cm  
0.3 mm 156800FX

**Fourche de guidage de Plester**  
16.5 cm  
Droit 156900FX  
Angle 45° 156945FX

**Crochet de Fisch**  
coudé à 90° - 16 cm  
Angle haut 156225FX  
Angle bas 156230FX

**Micro-aiguille de Schuhknecht**  
16 cm  
Droit, pointu, tige coudée 157100FX  
Droit, arrondi, tige coudée 157200FX



**Micro-crochet, coudé à 45°**  
16.5 cm  
0.2 mm 156102FX  
0.4 mm 156104FX  
0.5 mm 156105FX  
0.6 mm 156106FX  
0.8 mm 156108FX  
1.0 mm 156110FX  
1.2 mm 156112FX  
1.5 mm 156115FX  
2.0 mm 156120FX

**Micro-crochet, coudé à 45°**  
**Bague de couleur**  
16.5 cm  
0.2 mm 156102FX8  
0.4 mm 156104FX8  
0.5 mm 156105FX8  
0.6 mm 156106FX8  
0.8 mm 156108FX8  
1.0 mm 156110FX8  
1.2 mm 156112FX8  
1.5 mm 156115FX8  
2.0 mm 156120FX8

**Micro-crochet, coudé à 90°**  
16.5 cm  
0.2 mm 155102FX  
0.4 mm 155104FX  
0.5 mm 155105FX  
0.6 mm 155106FX  
0.8 mm 155108FX  
1.0 mm 155110FX  
1.2 mm 155112FX  
1.5 mm 155115FX  
2.0 mm 155120FX

**Micro-crochet, coudé à 90°**  
**Bague de couleur**  
16.5 cm  
0.2 mm 155102FX8  
0.4 mm 155104FX8  
0.5 mm 155105FX8  
0.6 mm 155106FX8  
0.8 mm 155108FX8  
1.0 mm 155110FX8  
1.2 mm 155112FX8  
1.5 mm 155115FX8  
2.0 mm 155120FX8



**Micro-crochet de Schuhknecht coudé gauche à 90°**  
16.5 cm  
0.2 mm 158202FX  
0.4 mm 158204FX  
0.6 mm 158206FX  
0.8 mm 158208FX  
1.0 mm 158210FX



**Micro-crochet de Schuhknecht coudé droite à 90°**  
16.5 cm  
0.2 mm 158302FX  
0.4 mm 158304FX  
0.6 mm 158306FX  
0.8 mm 158308FX  
1.0 mm 158310FX



**Micro-crochet de Schuhknecht coudé gauche à 90°**  
Bague couleur  
16.5 cm  
0.2 mm 158202FX8  
0.4 mm 158204FX8  
0.6 mm 158206FX8  
0.8 mm 158208FX8  
1.0 mm 158210FX8



**Micro-crochet de Schuhknecht coudé droite à 90°**  
Bague couleur  
16.5 cm  
0.2 mm 158302FX8  
0.4 mm 158304FX8  
0.6 mm 158306FX8  
0.8 mm 158308FX8  
1.0 mm 158310FX8



**Micro-crochet de Schuhknecht coudé haut à 90°**  
16.5 cm  
0.2 mm 158402FX  
0.4 mm 158404FX  
0.6 mm 158406FX  
0.8 mm 158408FX  
1.0 mm 158410FX



**Micro-crochet de Schuhknecht coudé bas à 90°**  
16.5 cm  
0.2 mm 158502FX  
0.4 mm 158504FX  
0.6 mm 158506FX  
0.8 mm 158508FX  
1.0 mm 158510FX



**Micro-crochet de Schuhknecht coudé gauche à 45°**  
16.5 cm  
0.2 mm 159202FX  
0.4 mm 159204FX  
0.6 mm 159206FX  
0.8 mm 159208FX  
1.0 mm 159210FX



**Micro-crochet de Schuhknecht coudé droite à 45°**  
16.5 cm  
0.2 mm 159302FX  
0.4 mm 159304FX  
0.6 mm 159306FX  
0.8 mm 159308FX  
1.0 mm 159310FX



**Micro-crochet de Schuhknecht coudé bas à 45°**  
16.5 cm  
0.2 mm 159102FX  
0.4 mm 159104FX  
0.6 mm 159106FX  
0.8 mm 159108FX  
1.0 mm 159110FX



**Micro-crochet de Schuhknecht coudé haut à 45°**  
16.5 cm  
0.2 mm 159402FX  
0.4 mm 159404FX  
0.6 mm 159406FX  
0.8 mm 159408FX  
1.0 mm 159410FX



**Pince Auriculaire de HARTMANN**  
Droite 8 cm  
Mors 8 mm striés 144 25508  
Mors 11 mm striés 144 26108  
Mors 11 mm griffes 1x2 144 26308



**Pince Auriculaire de HARTMANN**  
Mors curette - 8 cm  
ø 1.5 mm 144 25708  
ø 2.0 mm 144 26720  
ø 2.5 mm 144 26725  
ø 3.0 mm 144 26730



**Pince auriculaire de HARTMANN**  
6,5 cm  
12 cm 144 24112



**Pince auriculaire de HOFFMANN**  
8 cm  
ø 2 mm 199 60 6456



**Pince auriculaire STRUEMPEL**  
8 cm  
Droite- mors ovales 5 x 2,5 mm 199 60 6448

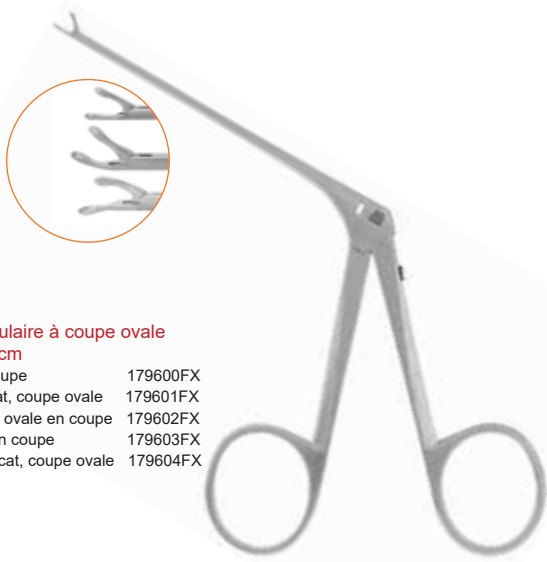

**Micro pince auriculaire à coupe ovale  
8cm**

- Droit, délicat, ovale en coupe 179600FX
- Courbée à gauche, délicat, coupe ovale 179601FX
- Courbée à droite, délicat, ovale en coupe 179602FX
- Courbée, délicat, ovale en coupe 179603FX
- Courbée vers le bas, délicat, coupe ovale 179604FX

**Micro-pince auriculaire de HARTMANN**  
Mors striés, longueur utile 80 mm

- 0.8 x 6 mm Droit 180100FX
- 0.8 x 4 mm Droit 180600FX
- 0.8 x 4 mm Courbé gauche 180601FX
- 0.8 x 4 mm Courbé droite 180602FX
- 0.8 x 4 mm Courbé haut 180603FX

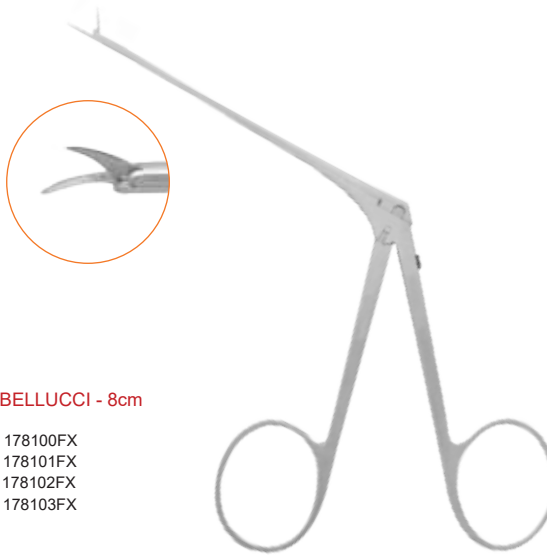

**Micro ciseaux de BELLUCCI - 8cm**  
Lame 0,8 x 4 mm

- Droits 178100FX
- Coudés haut 178101FX
- Coudés à gauche 178102FX
- Coudés à droite 178103FX

**Pince de DIETER**  
pour la tête du Marteau - 8 cm

- Coupant Haut 1,3 mm 181103FX
- Coupant Bas 1,3 mm 181104FX



**Micro Pince TUBULAIRE - 8 cm**

- Mors striés droits 181800FX
- Mors striés coudés à gauche 181801FX
- Mors striés coudés à droite 181802FX
- Mors ciseaux droits 178700FX



**Micro pince de MAC GEE - 8 cm**  
Mors striés 0,6 x 3,5 mm

- Droit 185100FX
- Coudé à gauche 185101FX
- Coudé à droite 185102FX





Burin de HAUTANT - 13 cm

- 1,0 mm 198 30 0010
- 1,5 mm 198 30 0015
- 2,0 mm 198 30 0020
- 3,0 mm 198 30 0030
- 4,0 mm 198 30 0040
- 5,0 mm 198 30 0050
- 6,0 mm 198 30 0060
- 7,0 mm 198 30 0070
- 8,0 mm 198 30 0080
- 9,0 mm 198 30 0090
- 10 mm 198 30 0100



Dissecteur de SEBILEAU

- Courbe
- 3 mm 198 20 0503
  - 4 mm 198 20 0504
  - 5 mm 198 20 0505



Gouge de POIRIER - 16 cm

- 2 mm 198 20 0702
- 3 mm 198 20 0703
- 4 mm 198 20 0704
- 5 mm 198 20 0705
- 6 mm 198 20 0706



Gouge de LECOINTRE - 16 cm

- 2 mm 198 20 0602
- 3 mm 198 20 0603
- 4 mm 198 20 0604
- 5 mm 198 20 0605



Gouge de HAUTANT - 13 cm

- 1,0 mm 198 20 0010
- 1,5 mm 198 20 0015
- 2,0 mm 198 20 0020
- 3,0 mm 198 20 0030
- 4,0 mm 198 20 0040
- 5,0 mm 198 20 0050
- 6,0 mm 198 20 0060
- 7,0 mm 198 20 0070
- 8,0 mm 198 20 0080
- 9,0 mm 198 20 0090
- 10 mm 198 20 0100



Rugine de LEMPert  
144 80720



Rugine de FARABEUf - 16 cm

	Droite	Courbe
4 mm	198 20 0104	198 20 0204
5 mm	198 20 0105	198 20 0205
6 mm	198 20 0106	198 20 0206
8 mm	198 20 0108	198 20 0208
10 mm	198 20 0110	198 20 0210
12 mm	198 20 0112	198 20 0212
14 mm	198 20 0114	198 20 0214



Rugine de SEBILEAU

	Demi-Courbe	Courbe
3 mm	198 20 0403	198 20 0503
4 mm	198 20 0404	198 20 0504



Rugine de HOWARTH  
196 48 0172



Etau de MARTIN lisse pour l'oreille  
198 00 0610



Écarteur de PLESTER - 13 cm  
Semi-tranchant  
2 x 2 griffes 118 65700



Écarteur de WEITLANER  
Semi-tranchant  
11 cm 2 x 3 griffes 118 65010  
14 cm 3 x 4 griffes 118 65014



Écarteur de WULLSTEIN - 13 cm  
Semi-tranchant  
3 x 3 griffes 118 65413

Écarteur de PLESTER - 11 cm  
2 griffes à droite lame à gauche 118 65711  
2 griffes à gauche lame à droite 118 65911



**Ciseaux de STEVENS - 11 cm**  
 Droits pointus 108 36011  
 Droits mousses 108 36211  
 Courbes pointus 108 36111  
 Courbes mousses 108 36311



**Ciseaux de METZENBAUM droits fins**  
 15 cm 108 28215  
 18 cm 108 28218



**Ciseaux de SPENCER - 11 cm**  
 Droits 108 80211



**Ciseaux STRABISME - 11 cm**  
 Droits 108 37011  
 Courbes 108 37111



**Ciseaux de RAGNELL - KILNER**  
 12 cm 108 31012  
 12 cm Lames Tungstène 108 31412  
 15 cm 108 31015  
 15 cm Lames Tungstène 108 31415



**Ciseaux de BEUSE crantés**  
 14 cm Droits 108 42014  
 Courbes 108 42114  
 18 cm Droits 108 42018  
 Courbes 108 42118



**Ciseaux de FOMON - 15 cm**  
 Coudés sur le plat 108 40315



**Ciseaux de MAYO - 14 cm**  
 Droits 108 16014  
 Courbes 108 16114

**Ciseaux de MAYO - 17 cm**  
 Droits 108 16017  
 Courbes 108 16117



**Ciseaux de REYNOLDS - 15 cm**  
Droits 108 32015  
Courbes 108 32115



**Ciseaux de JOSEPH - 15 cm**  
Droits 108 30414  
Courbes 108 30514



**Ciseaux de JOST**  
12 cm Droits 108 30112  
Courbes 108 30012  
14 cm Droits crantés 108 30214  
Courbes crantés 108 30314



**Ciseaux de LOCKLIN - 16 cm**  
Angulés 108 53916



**Ciseaux IRIDECTOMIE - 12 cm Micro Dentés**  
Droits 108 34011  
Courbes 108 34111



**Ciseaux de FOMON - 13 cm**  
Courbes sur le plat 108 40213



**Ciseaux de HEYMANN**  
Non crantés 108 40118  
Crantés 108 40119



**Ciseaux de COTTLE - 16 cm**  
108 40516



Packing RHINO stérile 15 x 13 mm  
Boite de 60 920715FX



Packing RHINO stérile 40 x 12 mm  
Boite de 40 920740FX



COTTLE  
Broyeur à cartilage 199 60 0600



Crochet de MILLARD - 18 mm  
large à double crochets 146 55218



Crochet anneau de COTTLE  
55 mm long 10 mm  
322900FX



Maillet chirurgical  
Inox 180 gr Embouts téflon  
128 08 0902



Maillet 200g - 18 cm  
face inox - téflon  
faces inox - téflon 132 69214



Maillet chirurgical  
Inox massif  
150gr 128 08 0900  
260gr 128 08 0901



**Pinces à dissection fines**

	sans griffes	avec griffes
110 11011	11.0 cm	110 13011
110 11013	13.0 cm	110 13013
110 11014	14.5 cm	110 13014
110 11016	16.0 cm	110 13016
110 11018	18.0 cm	110 13018
110 11020	20.0 cm	110 13020



**Pince de GILLIES - 15 cm**  
110 27215



**Pince de SEMKEN**  
12 cm sans griffes 110 26012  
avec griffes 110 27012  
15 cm sans griffes 110 26015  
avec griffes 110 27015



**Pince ADSON-BROWN - 12 cm**  
110 18812



**Pince de DUFOURMENTEL 3x4 griffes**  
13 cm 110 15013  
15 cm 110 15014



**Pince de CLAOUE 4 x 5 griffes - 15 cm**  
110 16014



**Pince de GRAEFE multigriffes - 11 cm**  
110 19010



**Pince de Mc INDOE - 15 cm**  
110 25815



**Pince de DE BAKEY**  
Mors 1.5 mm - 2.5 mm 2.0 mm - 2.5 mm 2.7 mm  
16 cm 111 30616 111 30816 111 30416  
20 cm 111 30620 111 30820 111 30420



**Pince de JANSEN**  
19cm  
199 60 7115





**Crochet de Freer**  
15 cm  
2 crochets 316500FX



**Crochet nasal de Fomon**  
Larg 10 mm 316700FX



**Crochet de Dufourmentel**  
Double mousse  
198 40 0020



**Crochet de Joseph**  
16 cm  
Largeur 2 mm 316602FX  
Largeur 5 mm 316605FX  
Largeur 7 mm 316607FX  
Largeur 10 mm 316610FX  
Largeur 12 mm 316612FX

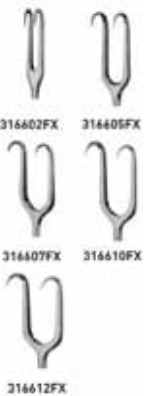

**Crochet de Cottle**  
15 cm  
Larg 10 cm 316100FX



**Crochet de Cottle**  
15 cm  
Larg 10 cm 316200FX



**Crochet de Cottle**  
15 cm  
Larg 10 cm 316300FX



**Ecarteur de COTTLE-NEIVERT**  
20 cm  
146 55920



**Ecarteur de CLAQUE**  
Double pointu 198 40 0110  
Double mousse 198 40 0111  
Simple Pointu 198 40 0115  
Simple mousse 198 40 0116



**Ecarteur d'AUFRICHT**  
Double - 13 cm  
199 60 7715



**Ecarteur KILNER 8cm**  
2 griffes  
146 55510



**Crochet nasal COTTLE**  
16cm  
199 60 7714



**Crochet nasal COTTLE**  
14cm  
199 60 7713



**Crochet de Frazier**  
13 cm 118 21413  
18 cm 118 21418



**Crochet de Cottle**  
15cm 317200FX



**Crochet de Gilles**  
18 cm  
N°2 cm 146 56018  
N°3 cm 146 56218

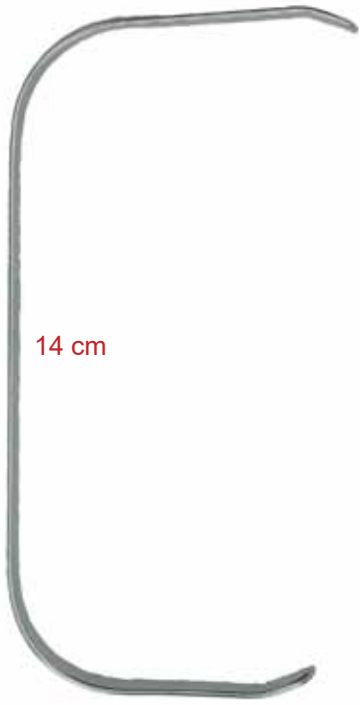

14 cm

Ecarteur Dautrey universel 60/80 mm  
196 10 1109  
Ecarteur Dautrey universel bords droits 60/80 mm  
196 10 1109S



14 cm

Ecarteur Dautrey court 40/55 mm  
196 10 1109C  
Ecarteur Dautrey court bords droits 40/55  
196 10 1110  
Ecarteur Dautrey long 50/90 mm  
196 10 1109L



14 cm

Ecarteur Dautrey 60/80  
avec aspiration sur le coté  
Aspiration sur côté long 80mm 196 10 1300  
Aspiration sur côté court 60mm 196 10 1400

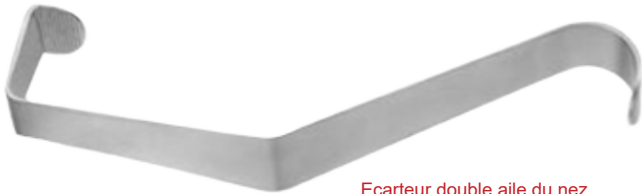

Ecarteur double aile du nez  
198 40 0100

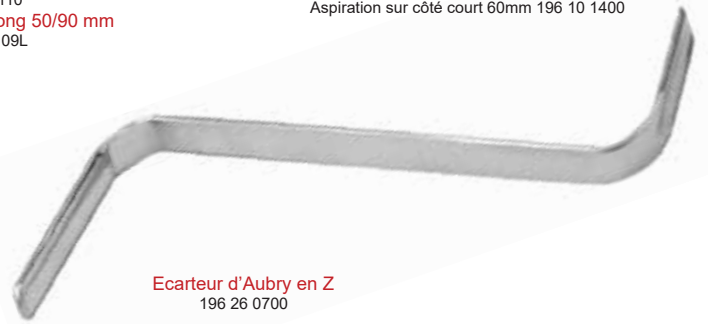

Ecarteur d'Aubry en Z  
196 26 0700



Ecarteur de FARABEU  
10 cm 196 10 0210  
12 cm 196 10 0214  
15 cm 196 10 0215



CONVERSE - 11 cm  
Lame 12 x 40 mm  
écarteur nasal 146 54105  
écarteur nasal avec fibre optique 146 54125



Ecarteur de SENN-MILLER  
Pointu 118 16017  
Mousse 118 16117



Ecarteur KASDEN  
16,5 cm  
118 24316



Ecarteur d'AUFRIEHT  
16 cm  
Standard 146 55116  
Avec lumière froide 146 55126  
Avec aspiration 146 55136

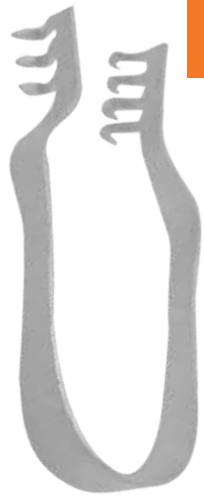

Ecarteur de FINSEN  
Pointu 118 61007  
Mousse 118 61107



Spatule de FREER  
18 cm  
146 41518



Spatule de KILLIAN  
22 cm  
Double - Mousse et Tranchante  
146 42622



Rugine nasale de COTTLE  
23 cm  
Extrémités légèrement courbe  
et très courbe  
5 mm 146 42123



Décolleur de COTTLE  
23 cm  
146 42322



Elevateur de MASING  
21,5cm  
4,5mm 199 60 7585



Lame malléable inox 8/10 mm 121 17 0040  
Lame malléable inox 12/14 mm 121 17 0050  
Lame malléable inox 14/16 mm 121 17 0060  
Lame malléable inox 16/20 mm 121 17 0070



Pince ADSON avec griffes  
12 cm 196 17 0112  
15 cm 196 17 0115



Pince ADSON sans griffes  
12 cm 196 17 0012  
15 cm 196 17 0015

Pince ADSON mors tungstène  
12 cm sans griffes 196 17 0412  
12 cm avec griffes 196 17 1412

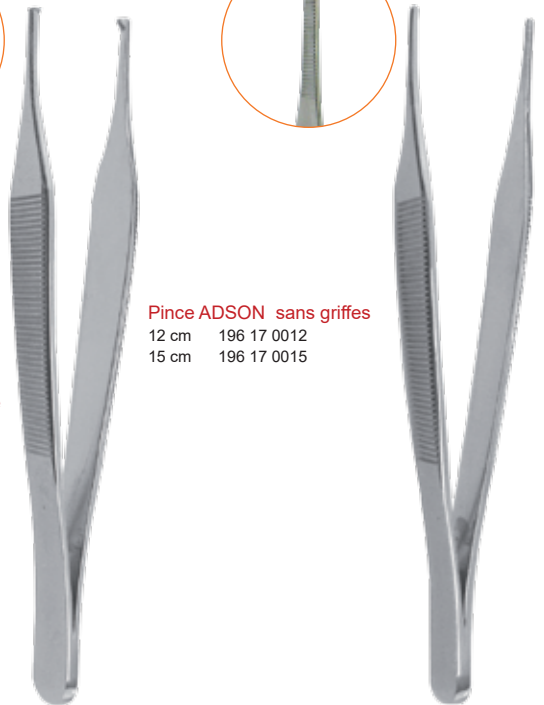



Rugine OBWEGESER  
18 cm

6 mm	146 42519/6
7 mm	146 42519/7
9 mm	146 42519/9
11 mm	146 42519/11



Rugine de FARABEU  
16 cm

	Droit	Courbe
4 mm	198 20 0104	198 20 0204
5 mm	198 20 0105	198 20 0205
6 mm	198 20 0106	198 20 0206
8 mm	198 20 0108	198 20 0208
10 mm	198 20 0110	198 20 0210
12 mm	198 20 0112	198 20 0212
14 mm	198 20 0114	198 20 0214



Rugine d' HOWARTH  
21cm  
196 48 0172



Rugine double de Mc. KENTY  
22cm  
4mm 199 60 0224



Rugine de MOLT - 17 cm  
196 46 7170



Rugine de JOSEPH - 17 cm  
Demi courbe 198 20 0840  
Courbe 198 20 0850



Gouge de KILLIAN-CLAUS  
En Rond 221100FX  
En V 221200FX



Rugine de Mc. KENTY  
Très courbe 15cm  
4mm 199 60 2104  
5mm 199 60 2105



Décolleur/rugine Williger - 4 mm  
124 08 0290  
Décolleur/rugine Williger - 6 mm  
124 08 0110  
Décolleur/rugine Williger - 15 mm  
196 46 7200  
Décolleur/rugine Williger - 20 mm  
196 46 7300



Décolleur de SEGURA - 4.0 mm  
Tranchant 198 10 0600  
Mousse 198 10 0500



Décolleur de MOLT Fin Galbé  
196 46 2619



Décolleur de BUSER  
196 46 7850



Ostéotome de COTTLE droit - 18 cm  
04 mm 307304FX  
06 mm 307306FX  
07 mm 307307FX  
09 mm 307309FX  
12 mm 307312FX



Ostéotome de COTTLE coudé - 18 cm  
06 mm 307206FX



Ostéotome de Lambotte mini droit  
12,5 cm 17 cm  
3 mm 132 65403 132 65503  
4 mm 132 65404 132 65504  
6 mm 132 65406 132 65506  
8 mm 132 65408 132 65508  
10 mm 132 65410 132 65510  
12 mm 132 65412 132 65512  
15 mm 132 65415 132 65515



Burin de CLAOUE-SENECHAL  
A butée 198 30 0120  
Bout mousse 198 30 0130



Burin de ROBIN avec guide  
06/08 mm 198 30 0108  
08/10 mm 198 30 0110  
10/14 mm 198 30 0114  
12/16 mm 198 30 0116  
14/18 mm 198 30 0118



Burin de COTTLE droit - 18 cm  
04 mm 307104FX  
07 mm 307107FX  
09 mm 307109FX  
12 mm 307112FX



Ostéotome de COTTLE - 18 cm  
avec guide  
5 mm 310600FX



Ostéotome de COTTLE - 18 cm  
avec barre transversale et guide  
5 mm 310605FX



Ostéotome de COTTLE - 18 cm  
avec barre transversale et guide  
10 mm 310610FX  
12 mm 310612FX  
14 mm 310614FX  
16 mm 310616FX

310610FX 310612FX 310614FX 310616FX



Burin de COTTLE - 18 cm  
avec barre transversale  
2 mm 307502FX  
4 mm 307504FX  
7 mm 307507FX  
9 mm 307509FX  
12 mm 307512FX



Ostéotome de COTTLE - 18 cm  
avec barre transversale  
4 mm 307604FX  
6 mm 307606FX

Ostéotome de COTTLE - 18 cm  
avec barre transversale  
4 mm 307804FX  
6 mm 307806FX



Ostéotomes de RUBIN 16cm  
10mm 306110FX  
12mm 306112FX  
14mm 306114FX  
16mm 306116FX

306110FX 306112FX 306114FX 306116FX





306610FX

306612FX

306614FX

306616FX

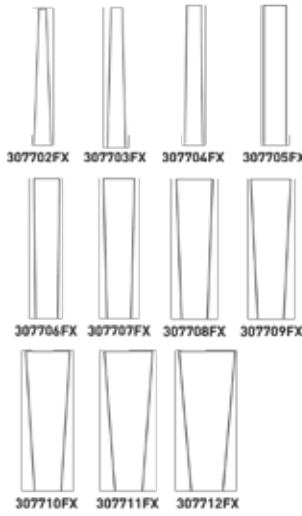

307702FX 307703FX 307704FX 307705FX

307706FX 307707FX 307708FX 307709FX

307710FX 307711FX 307712FX

Ostéotome de SHEEHAN / RUBIN  
Mache hexagonale - 16cm

2 mm	307702FX	8 mm	307708FX
3 mm	307703FX	9 mm	307709FX
4 mm	307704FX	10 mm	307710FX
5 mm	307705FX	11 mm	307711FX
6 mm	307706FX	12 mm	307712FX
7 mm	307707FX		



Ostéotomes de CONVERSE  
18 cm

Ostéotomes de MASING  
avec guide - 16 cm

2 mm	307902FX	8 mm	307902FX
3 mm	307903FX	9 mm	307902FX
4 mm	307905FX	10 mm	307902FX
5 mm	307905FX	11 mm	307902FX
6 mm	307906FX	12 mm	307902FX
7 mm	307907FX	14 mm	307902FX

10 cm 310105FX

Ostéotome WÜRZBURGER MODELL  
avec guide - 18 cm

Droit	3 mm	310800FX
Gauche	3 mm	310801FX
Droite	3 mm	310802FX

Ostéotomes de CINELLI  
16cm

10mm	306610FX
12mm	306612FX
14mm	306614FX
16mm	306616FX

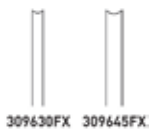

309630FX 309645FX

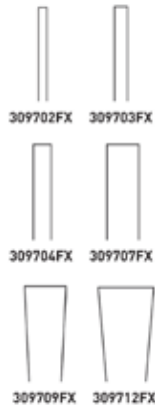

309702FX 309703FX

309704FX 309707FX

309709FX 309712FX

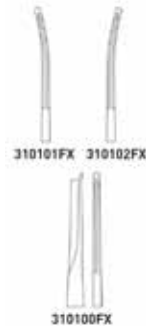

310101FX 310102FX

310100FX



308001FX



308002FX

Gouge de WALTER  
19 cm

3 mm	309630FX
4.5 mm	309645FX

Ostéotomes de WALTER  
19 cm

2 mm	309702FX
3 mm	309703FX
4 mm	309704FX
7 mm	309707FX
9 mm	309709FX
12 mm	309712FX

Ostéotomes de MASING  
avec guide - 18 cm

Droit	310100FX
Coudé à gauche	310101FX
Courbé à droite	310102FX

Ostéotomes de CONVERSE  
avec guide - 19 cm

5 mm droit	308000FX
5 mm coudé à gauche	308001FX
5 mm coudé à droite	308002FX



NT - Rhinoplasty SET du Professeur HOLT  
Micro Ostéotomes  
18 cm



NT - Rhinoplasty SET du Professeur HOLT  
Ostéotomes  
18 cm



**Curette de MOURE - 16 cm**  
 Droite 198 00 0300  
 Coudée à Droite 198 00 0310  
 Coudée à gauche 198 00 0320



**Curette de LUC 10 mm**  
 17 cm  
 Droite 198 00 0350  
 Coudée à Droite 198 00 0360  
 Coudée à gauche 198 00 0370



**Curette de SEBILEAU**  
 21 cm  
 Droite Courbe  
 5 mm 198 00 0005 198 00 0205  
 6 mm 198 00 0006 198 00 0206  
 7 mm 198 00 0007 198 00 0207



**Curette de LIMA**  
 27 cm  
 3 mm 198 00 0413  
 5 mm 198 00 0415  
 7 mm 198 00 0417



**Rape de MATLZ**  
 17 cm  
 Poussant 198 40 0230  
 Tirant 198 40 0240



**Rape AUFRIEHT**  
 21 cm  
 Poussant 199 60 2902  
 Tirant 199 60 2903



**Rape d'AUBRY - 7 mm**  
 Tirant 198 40 0200  
 Poussant 198 40 0210



**Rape de FOMON tungstène**  
 3/4 146 52203  
 5/6 146 52505  
 7/8 146 52207



**Rape de GLABELLA**  
 tungstène  
 146 50501



**Rape de COOTLE**  
 146 51821



**Rape de PEET**  
 Droite 146 50919  
 Courbe 146 50920



**Rape de LAMONT**  
 Gros Grain 146 53101  
 Grain fin 146 53103  
 Grain très fin 146 53102

**Porte-aiguille CRILE-WOOD**

mors tungstène  
15 cm 124 16415  
18 cm 124 16418



**Porte-aiguille MAYO-HEGAR**

tungstène / Inox  
124 18414 14 cm 124 18014  
124 18418 16 cm 124 18016  
124 18418 18 cm 124 18018  
124 18420 20 cm 124 18020



**Porte-aiguille de HASLEY**

mors tungstène  
13 cm 196 06 0590



**Porte-aiguille de RYDER**

mors tungstène  
13 cm 124 22413  
15 cm 124 22415  
18 cm 124 22418



**Porte-aiguille de DOYEN**

12,5 cm mors Inox 124 11012



**Porte-aiguille de FINOCHIETTO**

13 cm mors Inox 198 00 0500



**Porte-aiguille de HOLSEN-HEGAR - 14 cm**

mors tungstène / mors Inox  
124 41414 121 41014



**Porte-aiguille de GILLIES - 16 cm**

mors tungstène / mors Inox  
124 43416 124 43016





**Pince gouge de LEMPert**  
3 mm - 16 cm  
droite 132 15016  
courbe 132 15116

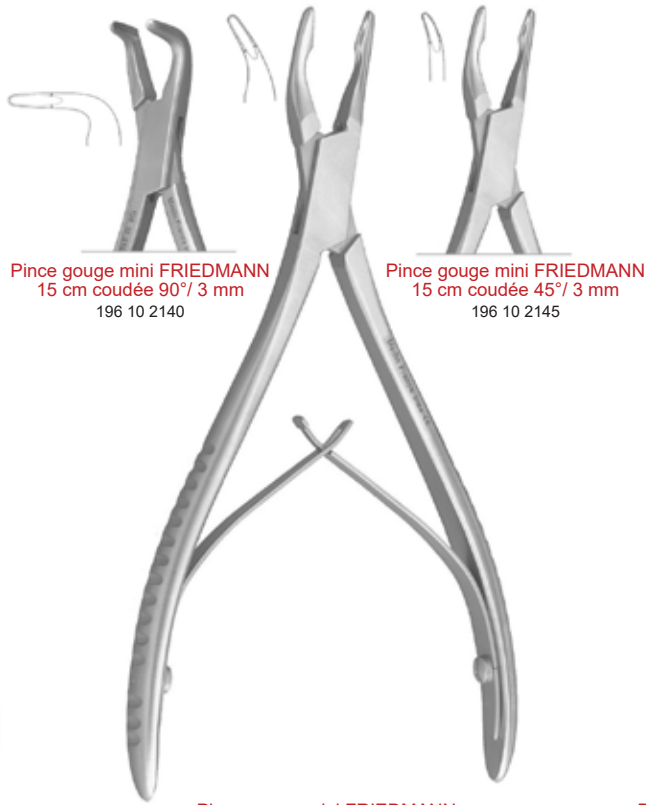

**Pince gouge mini FRIEDMANN**  
15 cm coudée 90° / 3 mm  
196 10 2140

**Pince gouge mini FRIEDMANN**  
15 cm coudée 45° / 3 mm  
196 10 2145

**Pince gouge mini FRIEDMANN**  
15 cm coudée 30° / 3 mm  
196 10 2150



**Pince de DUFOURMONT**  
198 50 0150



**Pince de ASCH**  
Coudée 146 57123



**Pince gouge de BOHLER**  
Double articulation 15 cm / 5 mm  
Droite 132 21115  
Courbe 132 21315



**Pince à cartilage de RUBIN**  
21 cm  
Mors inox 146 25020  
Mors Tungstène 146 25021



**Ciseaux nasaux de CAPLAN** 21cm  
Courbes – double articulation  
Lames inox 199 60 0360  
Lames Tungstène 199 60 0370

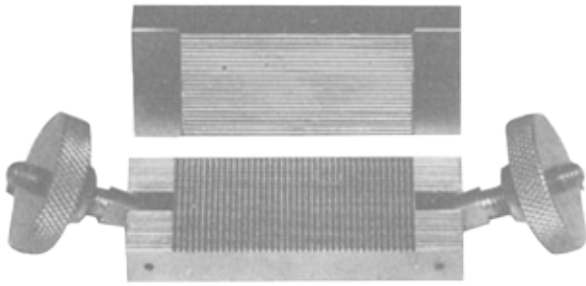

Etau de JOST strié pour le nez  
198 00 0600



Pince de WALSHAM  
Droite 146 57223  
A gauche 146 57323  
A droite 146 57523



Pince de JANSEN  
19 cm mors curette  
146 32319



Pince de LUC fenêtrée  
12 x 8 mm 146 19701  
17 x 11 mm 146 19702



Scie d'AUBRY  
A droite 146 53419  
A gauche 146 53219



Pince emporte pièces de CITELLI  
8 cm  
1 mm 146 31110  
2,5 mm 146 31125  
4 mm 146 31140



Pince emporte pièces de KERRISON  
9 cm  
3 x 3 mm 146 30303  
4 x 4 mm 146 30304  
5 x 5 mm 146 30305  
6 x 6 mm 146 30306





**Pince de TAKAHASHI**  
11 cm

Droit 10 X 2.5 mm 227100FX  
Droit 10 X 3 mm 227101FX  
Coudé 45° 10 X 3 mm 227202FX



**Pince de WATSON-WILLIAMS**  
11 cm

Droit, dentelée 234100FX  
Angulé 45°, dentelée 234145FX



**Pince de STRUEMPEL-VOSS**  
11 cm

Angulé 45° 230400FX



**Pince de STRUYCKEN**  
11 cm

Mors long 227600FX



**Pince de BLAKESLEY**  
11 cm

Droit	45°	90°
3.0 mm 230100FX	3.0 mm 230200FX	3.0 mm 230300FX
3.5 mm 230101FX	3.5 mm 230201FX	3.5 mm 230301FX
4.0 mm 230102FX	4.0 mm 230202FX	4.0 mm 230302FX
5.0 mm 230103FX	5.0 mm 230203FX	5.0 mm 230303FX
5.5 mm 230104FX	5.5 mm 230204FX	5.5 mm 230304FX

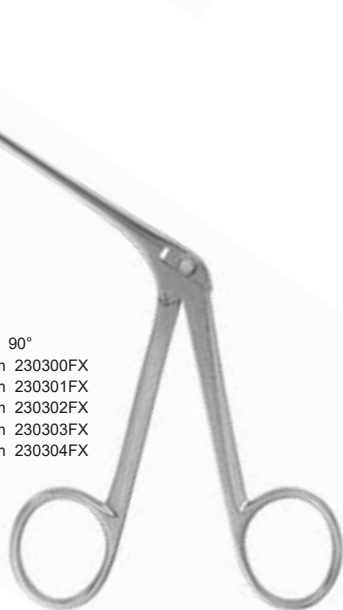

**Pince de BLAKESLEY**  
15 cm

Droit	45°	90°
3.5 mm 231601FX	3.5 mm 231701FX	3.5 mm 231801FX
4.0 mm 231602FX	4.0 mm 231702FX	4.0 mm 231802FX
5.0 mm 231603FX		

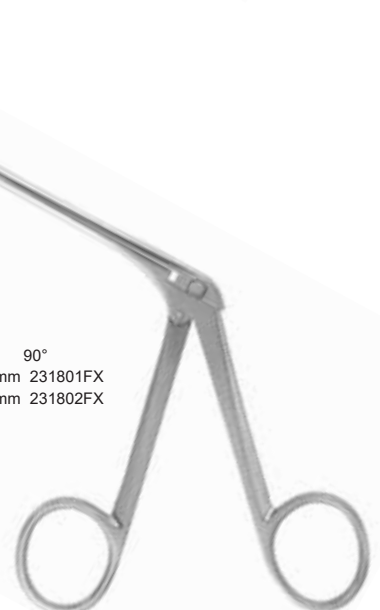



Pince coupante nasale  
de HARTMANN  
11 cm

- 5 mm 229101FX
- 7 mm 229102FX
- 9 mm 229103FX
- 11 mm 229103FX



Pince coupante nasale  
de Schmeden  
11 cm

- 6 mm 228100FX
- 7 mm 228101FX
- 8 mm 228102FX

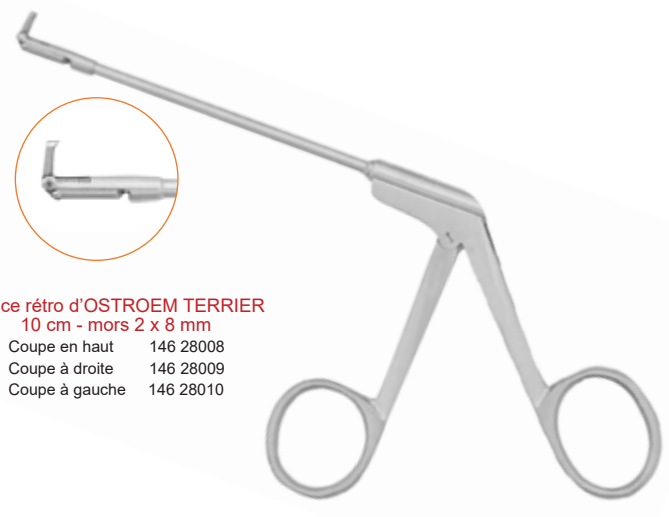

Pince rétro d'OSTROEM TERRIER  
10 cm - mors 2 x 8 mm

- Coupe en haut 146 28008
- Coupe à droite 146 28009
- Coupe à gauche 146 28010



Pince coupante nasale  
de GRUENWALD-HENKE  
11 cm

- 3.0 mm 228601FX
- 3.5 mm 228602FX
- 4.0 mm 228603FX



Pince coupante nasale  
14 cm

- Doit Fine 226901FX



Pince coupante nasale  
14 cm

- 45° 226902FX



Ciseaux nasaux  
11.5 cm

- |                          |          |
|--------------------------|----------|
| Droits, lisses           | 226400FX |
| Courbés à gauche, lisses | 226401FX |
| Courbé à droite, lisses  | 226402FX |



Ciseaux nasaux de HEYMANN  
9.5 cm

- |   |          |
|---|----------|
| lames standard et lisses                  | 226100FX |
| petites lames lisses                      | 226109FX |
| grandes lames lisses (11 cm)              | 226111FX |
| lames dentelées standard                  | 226200FX |
| petites lames courbées à gauche et lisses | 226201FX |
| petites lames courbées à droite et lisses | 226202FX |



Ciseaux nasaux  
13 cm

- |                                |          |
|--------------------------------|----------|
| Droits, micro-dentés           | 226300FX |
| Courbés à gauche, micro-dentés | 226301FX |
| Courbés à droite, micro-dentés | 226302FX |



Pince à septum de Craig  
18 cm

Droit 233100FX  
Courbé 233200FX

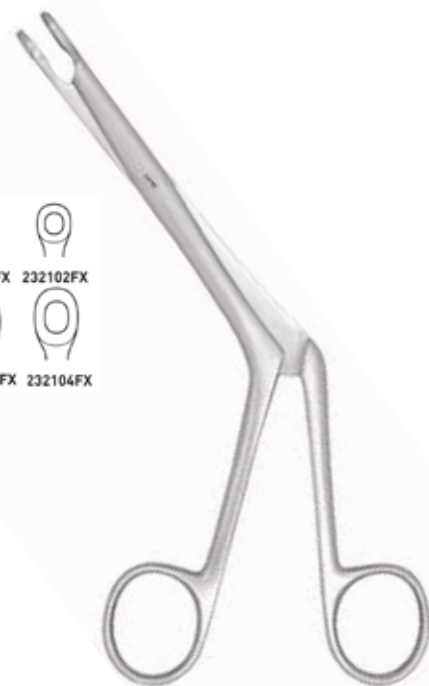

Pince à septum  
de Bruenings  
11 cm

Taille 1 232101FX  
Taille 2 232102FX  
Taille 3 232103FX  
Taille 4 232104FX



Pince nasale de WESTMACOTT  
20 cm

Fine 223600FX  
Très fine 224100FX



Pince nasale de SHEEN - KILLIAN  
17,5 cm

199 60 7145



Canule aspiration Frazier

Droite		Coudée	
196 01 0202	Ø 2 mm	196 01 0205	
196 01 0200	Ø 3 mm	196 01 0203	
196 01 0201	Ø 4 mm	196 01 0204	

Canule d'aspiration à plaque 15 cm

Ø 2.0 mm	196 99 0020
Ø 3.0 mm	196 99 0030
Ø 4.0 mm	196 99 0040

Lancette coagulante

16 cm	196 99 0100
23 cm	196 99 0200

Canule aspiration coagulante 23 cm

Ø 3.0 mm	196 99 0230
Ø 4.0 mm	196 99 0240

Canule d'aspiration en S

Ø 2.5 mm	196 99 0010
Ø 3.0 mm	196 99 0011
Ø 3.5 mm	196 99 0012

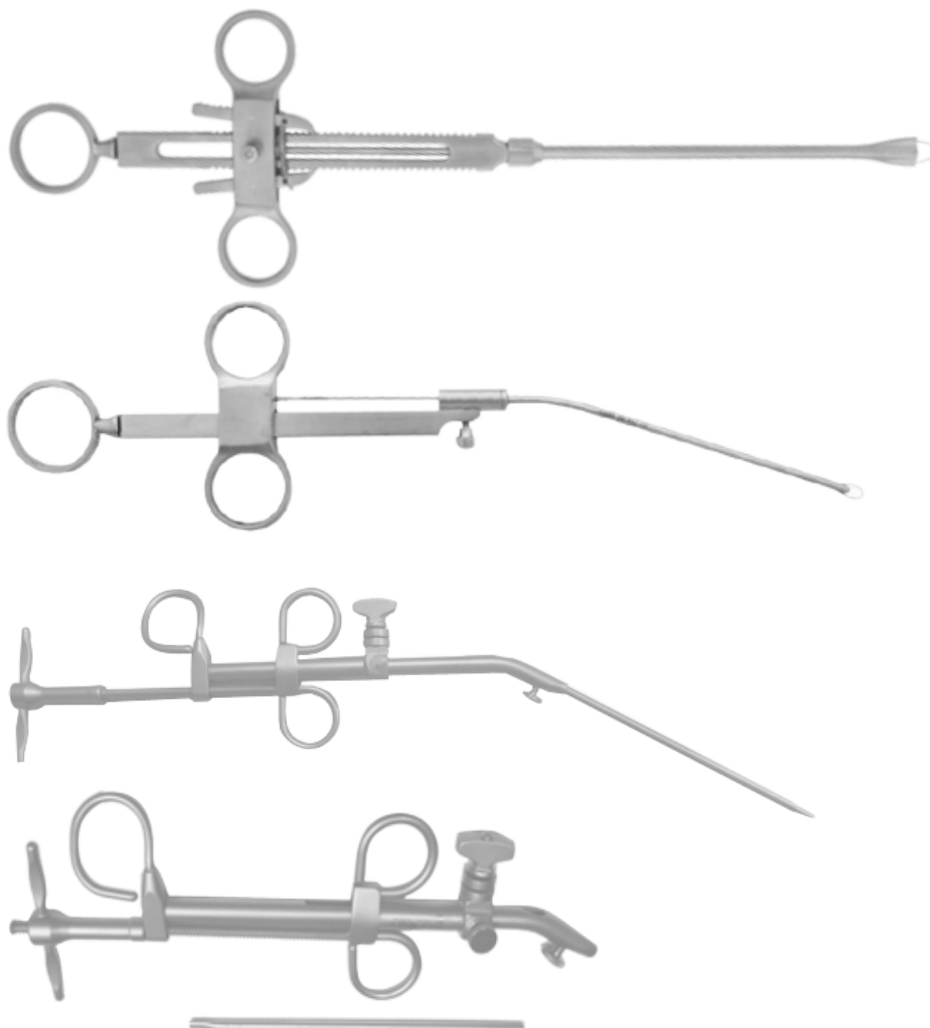

Serre-noeud de BRUNNINGS

28 cm 150 25628

Anse pour BRUNNINGS sachet de 100

40 mm 150 25740  
50 mm 150 25750

Serre-noeud de KRAUSS - 26 cm

146 35126

Anse pour KRAUS sachet de 12 - 0,3 m

146 35503

Serre-noeud de LERMOYER

198 10 0800

Fil pour serre-noeud LERMOYER et VACHER

Rouleau de 2 m  
0.4 mm 198 10 0804  
0.6 mm 198 10 0806

Serre-noeud de VACHER

198 10 0900



**Ouvre-bouche de DAVIS - BOYLE**

- Adulte complet (cadre+5 spatules) 148 31000
- Cadre seul 148 31010
- spatule 20x25 mm 148 31005
- spatule 22x60 mm 148 31004
- spatule 25x75 mm 148 31003
- spatule 25x90 mm 148 31002
- spatule 27x105 mm 148 31001

Les spatules adulte s'adaptent aussi sur le KILNER

Enfant complet (cadre+5 spatules) 148 30900

- Cadre seul 148 30910
- spatule 17x26 mm 148 30901
- spatule 19x46 mm 148 30902
- spatule 20x58 mm 148 30903
- spatule 22x71 mm 148 30904
- spatule 22x80 mm 148 30905



**Ouvre-bouche de MAC-IVOR**

- Complet (cadre+3 spatules) 148 32000
- Cadre seul 148 32010
- spatule 22x70 mm 148 32003
- spatule 22x85 mm 148 32002
- spatule 27x95 mm 148 32001

L' Ouvre-bouche de MAC-IVOR accepte aussi les spatules de DAVIS - BOYLE et KILNER



**Ouvre-Bouche de KILNER**

- Complet (cadre+3 spatules) 148 31500
- Cadre seul 148 31510
- Spatules 28x65 mm 148 31501
- 32x75 mm 148 31002
- 37x80 mm 148 31503

Les spatules s'adaptent aussi sur l'ouvre-bouche DAVIS - BOYLE



**Ouvre-bouche de JENNINGS**

- 9 cm 148 27409
- 11 cm 148 27411
- 13 cm 148 27413
- 15 cm 148 27415



**Ouvre-bouche de DOYEN enfant**

196 26 5120

**Ouvre-bouche de DOYEN adulte**

196 26 5140

**Embout de protection silicone**

(sachet de 10)

196 26 5141

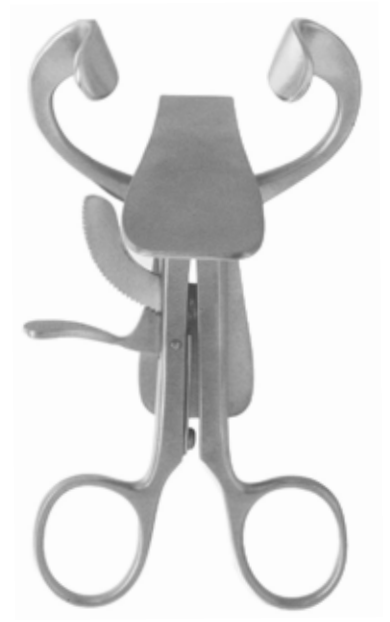

**Ouvre bouche abaisse langue**

197 07 0000

**Embout de protection silicone**

(sachet de 10)

196 26 5141



Abaisse-langue de LECOUBEUR  
198 40 0350



Abaisse-langue de LE MEE  
avec aspiration  
Adulte 198 40 0400  
Enfant 198 40 0401



Abaisse-langue de CHATELIER  
Spatule 20 mm 198 40 0320  
Spatule 25 mm 198 40 0325  
Spatule 30 mm 198 40 0330



Abaisse-langue avec aspiration  
Sans panier 198 40 0410  
Avec panier adulte 198 40 0420  
Avec panier enfant 198 40 0430



Couteau de MOURE  
Avec panier Sans panier

198 40 0510	10 mm	198 40 0610
198 40 0513	13 mm	198 40 0613
198 40 0516	16 mm	198 40 0616
198 40 0519	19 mm	198 40 0619
198 40 0521	21 mm	198 40 0621



Couteau de BECKMANN

10 mm	146 62001
13 mm	146 62002
15 mm	146 62003
17 mm	146 62004
19 mm	146 62005



Couteau de LUBET-BARBON  
pour nourrisson

8 mm	198 40 0708
10 mm	198 40 0710
12 mm	198 40 0712



Couteau de LERMOYER

10 mm	198 40 0700
13 mm	198 40 0713
16 mm	198 40 0716
19 mm	198 40 0719





Dilatateur de TROUSSEAU  
154 11114



Dilatateur de LABORDE  
154 11314



Cisaille de MOURE  
198 10 0700



**Canule d'OMBREDANNE**

Canule complète 104 15027  
Embout d'aspiration 104 15098

**Adémotome de LA FORCE**

Petit - 13 cm 146 64101  
Moyen 18 cm 146 64102  
Grand 20 cm 146 64103

**Faux de RUAAULT - 22 cm**

Pointue 198 10 0610  
Mousse 198 10 0620

**Spatule de HURD - 22 cm**

Lisse 150 13122  
Dentellée 150 13322

**Spatule de CARPENTIER - 25 cm**  
150 13925

**Peigne de JOST**  
198 10 0650

**POUSSE FIL**  
199 35 0300

**Curette de VOLKMANN**  
13 mm 132 47005  
15 mm 132 47006



**Pince Fenêtrée - 20 cm**  
 Droite 116 17020  
 Courbe 116 17120



**Pince de MAGILL**  
 Adulte 104 19025  
 Enfant 104 19017



**Ciseaux à amygdales de BOETTCHER - 18 cm**  
 108 43518



**Ciseaux à amygdales de GOOD - 19 cm**  
 108 43 719



**Ciseaux à amygdales de PRINCE - 17 cm**  
 108 43 917



**Ciseaux de DEAN - 17cm**  
 Lames lisses 108 42517  
 Lames dentellées 108 42717



**Pince de BOURGEOIS**  
198 50 0010



**Pince de NEGUS**  
Courbe 150 19119  
Très courbe 150 19319



**Pince de CHATELIER**  
Mors 6 mm 198 50 0006  
Mors 8 mm 198 50 0008



**Pince de O'SCHAUGNESSY**  
14 cm 198 50 0114  
16 cm 198 50 0116  
18 cm 198 50 0118  
20 cm 198 50 0120



**Pince de BLOHMKE**  
20 cm  
150 20920



**Pince de MUSEUX**  
8 mm Droite 170 52408  
8 mm Courbe 170 52508  
10 mm Droite 170 52410  
10 mm Courbe 170 52510



**Pince de PORTMANN**  
19 cm  
Courbe 150 20319



**Tube rallonge pour Poignée universelle HUBER**

	Droite	Courbe
20 cm	152 13220	152 13120
30 cm	152 13230	
40 cm	152 13240	
50 cm	152 13250	
60 cm	152 13260	



**Embout de FRAENKEL**

Mors striés 152 15000



Mors curette 152 15400



**Embout de SEIFFERT**

Mors à griffes 152 15200



**Embout de KRAUSE - mors rongeur oval**

Petit 152 16401

Moyen 152 16402



**Embout de BRUENINGS - mors ronds**

3 mm 152 15802

4 mm 152 15803



**Embout de CORDES - mors rongeur**

Petit 152 17201

Moyen 152 17202



**Embout de SHEINMANN - mors curette**

coudés 152 15500



**Poignée universelle HUBER**  
152 13000



**Pince de JURASZ**

Mors mobiles supérieurs	152 11504
Mors mobiles inférieurs	152 11503
Mors mobiles à gauche	152 11502
Mors mobiles à droite	152 11501



**Pince de HARTMANN**  
emporte-pièces

Ø 05 mm	146 23505
Ø 07 mm	146 23507
Ø 09 mm	146 23509
Ø 11 mm	146 23511



**Amygdalotome de SLUDER**

Complet (Manche + 3 lames n°1, 2, 3)	150 27000
Lame N°1	150 27001
Lame N°2	150 27002
Lame N°3	150 27003
Manche seul	150 27100



Appui PECTORAL  
LARYNGOSCOPE en suspension  
Appui complet sans spatule  
196 99 0400



Spatule de FRECHE Fibrée  
Adulte 190 mm 196 99 0410  
Enfant 170 mm 196 99 0420  
Nourrisson 150 mm 196 99 0430



Spatule de FLORANT fibrée  
180 mm 196 99 0450



Spatule de PIGNAT fibrée  
Adulte 196 99 0460  
Enfant 196 99 0470  
Nourrisson 196 99 0480



Oesophagoscope avec fibre  
optique et aspiration  
Enfant 30 cm - Ø 9 mm 196 99 0510  
Adulte 50 cm - Ø 12 mm 196 99 0512



Hypopharyngoscope de GEHANNO  
avec fibre optique et aspiration  
15 cm - Ø 15 mm 196 99 0515  
20 cm - Ø 15 mm 196 99 0520  
Adaptable sur poignée - réf. 196 99 0600  
ou système laryngoscope en suspension - réf. 196 99 0400



Hypopharyngoscope  
avec fibre optique et aspiration  
20 cm - Ø 10 mm 196 99 0550  
25 cm - Ø 10 mm 196 99 0560

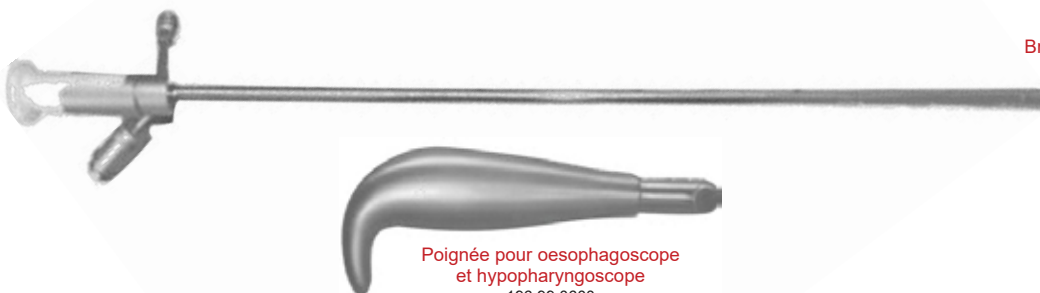

Poignée pour oesophagoscope  
et hypopharyngoscope  
196 99 0600

Bronchoscope avec fibre optique et aspiration  
Enfant 30 cm  
Ø 4.0 mm 196 99 0504  
Ø 5.0 mm 196 99 0505  
Ø 6.0 mm 196 99 0506  
Adulte 40 cm  
Ø 7.0 mm 196 99 0507  
Ø 8.0 mm 196 99 0508  
Ø 9.0 mm 196 99 0509